



SOLSOLO



**SHENZHEN GROWATT NEW ENERGY TECHNOLOGY CO.,LTD**

No.28 Guangming Road, Shiyan Street, Bao'an District,  
Shenzhen, P.R.China

**T** + 86 755 2747 1942

**F** + 86 755 2747 2131

**E** [service@ginverter.com](mailto:service@ginverter.com)

**W** [www.ginverter.com](http://www.ginverter.com)

## GroBoost quick installation guide

# CONTENT

- 1 Overview
- 2 Installation
- 3 Multiple Work Modes
- 4 Device parameters
- 5 Common Problem
- 6 APP Register
- 7 GroBoost Setting the Groboost via Shinephone APP
- 8 Contact us

# 1 Overview

## 1.1 Package List

Open the package, take out all the accessories, and check the quantity of all the components in the box according to the package list, As shown in Figure 1-1 and Table 1-1.

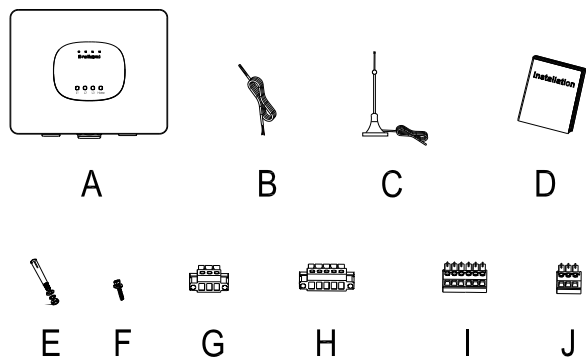

Figure 1-1

Code	Accessories	Number
A	GroBoost whole machine	1
B	Pt1000 temperature sensor	1
C	Antenna	1
D	Quick installation guide	1
E	Wall-mounted bracket Screws	3
F	Seal bottom cover screw	4+2 (More than)
G	3 PIN large load terminal	4
H	5 PIN AC input large terminal	1
I	6 PIN PT1000 small terminal	1
J	3 PIN RS485 and 12VDC small terminal block	2

Table 1-1

## 2.1 Product description

ShineLink adopts a device-gateway-server-client architecture model, which uses gateways and servers to link household energy equipment with homeowners to realize the entire function of monitoring, analysis, and scheduling. Among them, GroBoost could control the temperature of the water heater, and work automatically when the solar system has surplus power exporting to the grid to maximize solar self-consumption.

GroBoost is a power regulator to adjust its power output automatically based on resistive loads through wireless commands. With the ShineLink system, it communicates with ShineLanBox through RF signal, accepts commands to adjust power output, and realizes system energy distribution and scheduling. The diagram of one of its application scenario is shown in Figure 1-2, in which the Inverter is communicated with the meter through RS485, and communicate with the LanBox through ShineRFstick.

This application scenario is suitable for the Growatt new generation inverter, like MIN, MID, MOD, SPH and SPA series, which could support to upload the energy meter date to the server.

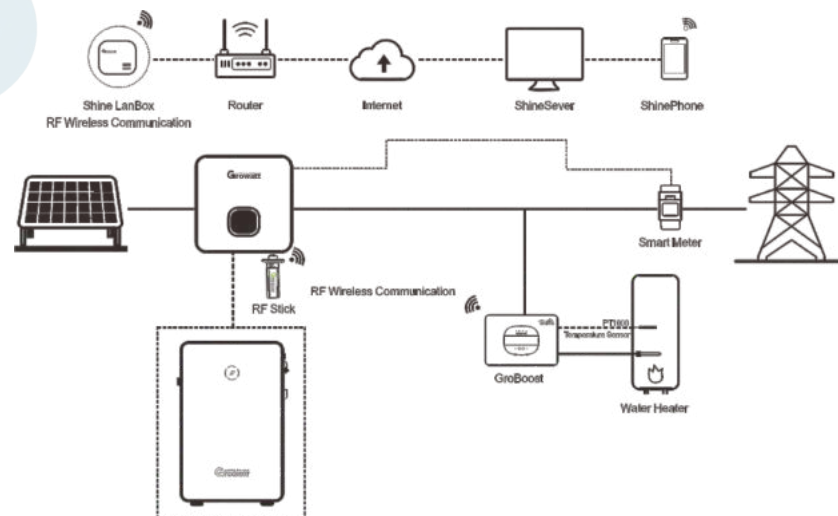

Figure 1-2

The diagram of another application scenario is shown in Figure 1-3, the smart meter data is transmitted wirelessly to the LanBox through RailLog, which is suitable for the -s series inverter which can't upload the energy meter data to the server.

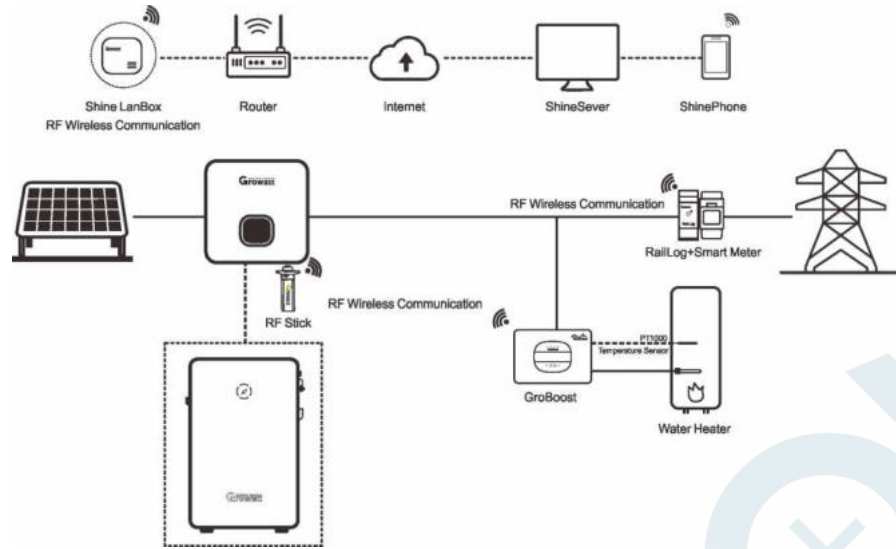

Figure 1-3

### 1.1 GroBoost Interface

As shown in Figure 1-4, the device has four indicator lights, four function buttons and three waterproof connector, corresponding to different wiring input. The functions and definitions are shown in Table 1-2.

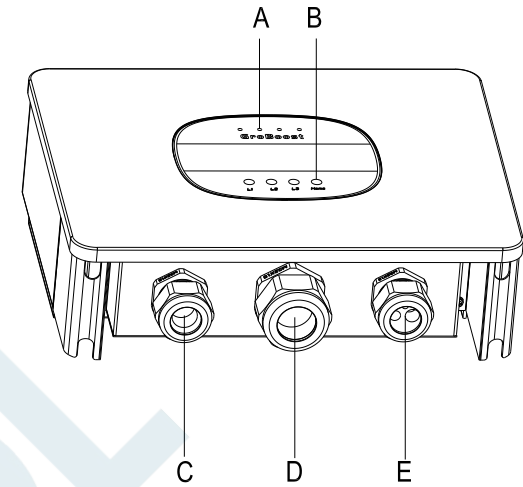

Figure 1-4

No	Description	No	Name	Description
A	Indicator lights	1	LED1	Indicator lights for phase L1
B	Buttons	2	LED2	Indicator lights for phase L2
C	Power cord terminal	3	LED3	Indicator lights for phase L3, and for the RF communication status
D	Load wire terminal	4	LED4	Power indicator
E	Signal wire terminal	5	L1	Phase L1 control button
		6	L2	Phase L2 control button
		7	L3	Phase L3 control button
		8	Home	RF pairing / Reset / FactoryReset

Table 1-2

The following figure 1-5 is the wiring interface of GroBoost, and its functions and definitions are detailed in Table 1-3.

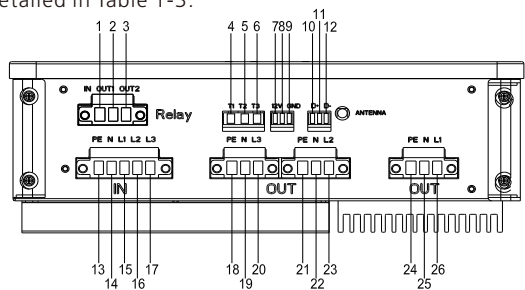

Figure 1-5

NO	Description	NO	Description
1	Relay A input port	14	Input N zero line
2	Relay B output port	15	Enter L1 FireWire
3	Relay C output port	16	Enter L2 FireWire
4	TP1000—L1	17	Enter L3 FireWire
5	TP1000—L2	18	Output PE earth wire
6	TP1000—L3	19	Output N zero line
7	12V DC-DC	20	Output L3 FireWire
8	12V DC-DC	21	Output PE earth wire
9	GND (12V DC)	22	Output N zero line
10	RS485+ (D+)	23	Output L2 live wire
11	EARTH	24	Output PE earth wire
12	RS485- (D-)	25	Output N zero line
13	Input PE earth wire	26	Output L1 live wire

Table 1-3

## 2 Installation

Notice:

1. Make sure to read the instructions to understand product information and safety precautions before installation;
2. The installer must use insulated tools and wear safety equipment during the installation procedure;
3. Construct sun and rain shelters to avoid GroBoost directly exposed to sunlight and rain.

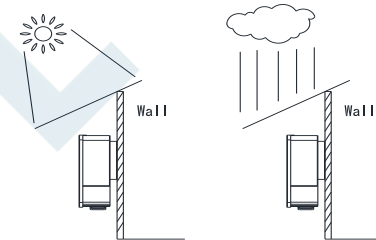

Figure 2-1

Installation Process

1. Fix the wall-mounted bracket hanging on the wall with screws, drill holes in the wall after positioning the four screw holes, put the plastic expansion tube, and screw into the wall, to fix the wall hanging.

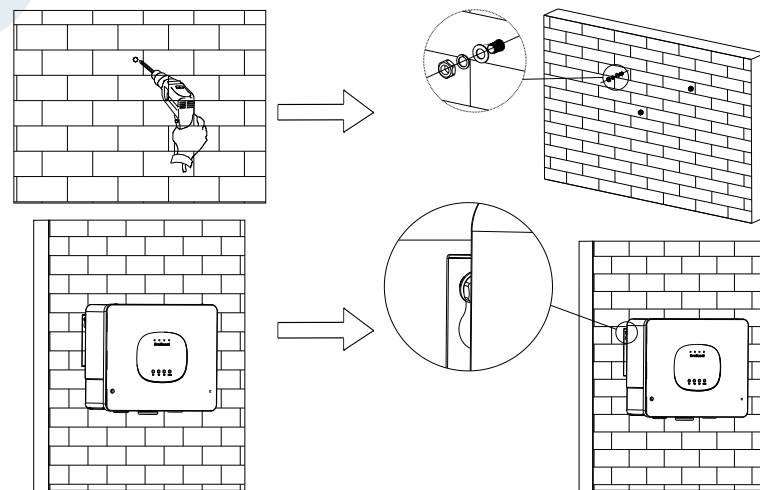

Figure 2-2

2. There are four screws on the bottom cover of the whole machine, please use a screwdriver to dismantle the screws.

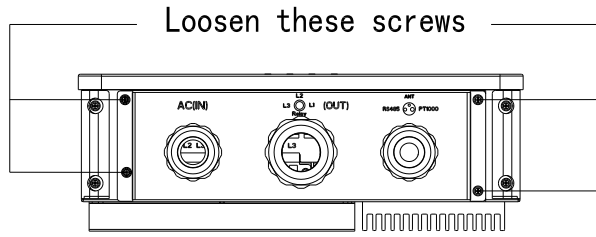

Figure 2-3

3. Remove the lower cover and start to wire it.

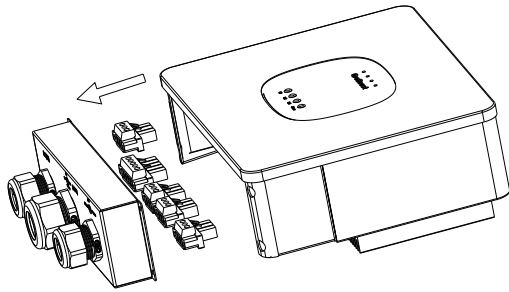

Figure 2-4

4. The wire harness passes through the corresponding three terminals and screwed them on the terminals. A 5 pin three-phase power input terminal is for power input line, 3 pin power output terminals is for loads, and the 3 pin RS485 and 12Vdc terminals are for the communication of the future application.

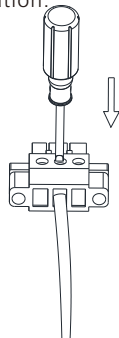

Figure 2-5

5. Screw the wire on the male terminal, connect it to the corresponding female socket of the device, and fix screws on both sides of the terminal to fix the terminals

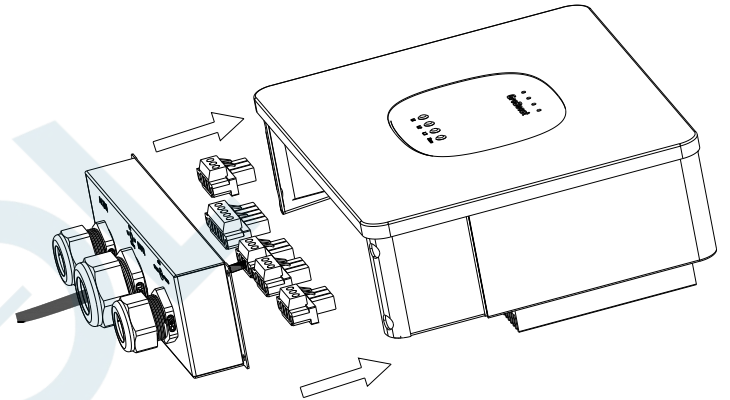

Figure 2-6

6. Adjust wiring distance and screw the four screws fixing the sealing lower cover to fix the lower cover

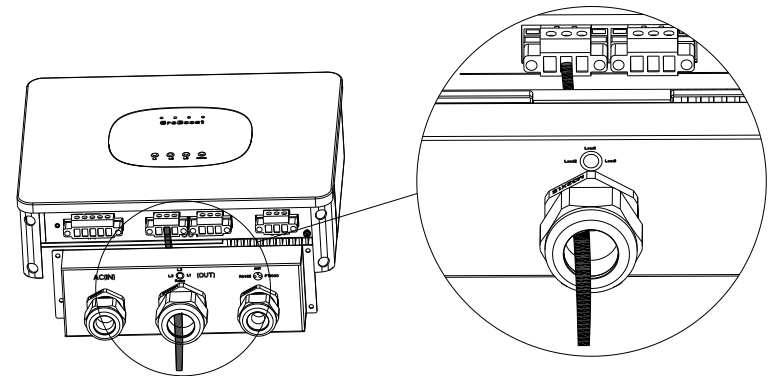

Figure 2-7

7. Adjust the length of the power and load lines, screw the covers, adjust the wiring head to reduce the space, and make the sealing degree higher.

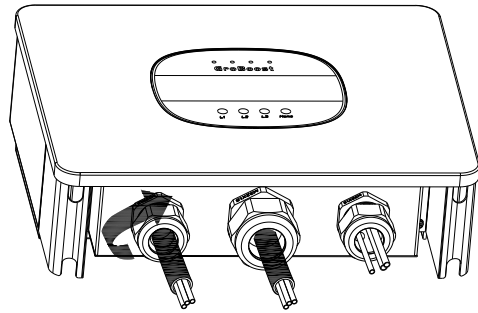

Figure 2-8

8. Fix the GroBoost on the wall, and tighten the screws on the side.

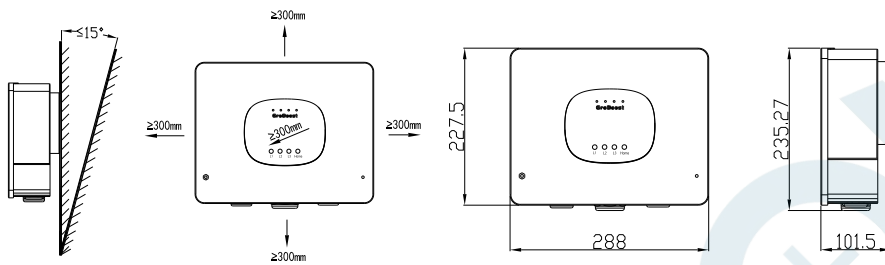

Figure 2-9

GroBoost Notice for wiring:

1. Remove the lower cover of GroBoost, and you need to pass the wire harness through the corresponding three terminals to prevent the wire harness from being twisted.
2. Use a no less than 4mm copper core wire for the power line, ground line, and load line. After stripping the wire, make sure that the wire is not too long, generally 10mm. For 485 communication lines please use shielded twisted wire.
3. Put the stripped wire into the terminal and use a flat-blade screwdriver to fix the wire, and then connect it to the device.
4. The antenna needs to be led out of the device to prevent signal shielding.

## 3 Multiple Work Modes

### 3.1 Load Wiring

The diverse load situation corresponds to different wiring ways. In addition, if the immersion heater doesn't have a temperature sensor, and the GroBoost needs to use the temperature sensors (Pt1000). The following table 3-1 shows the wiring diagram of a diverse load situation. The following figure is the overall detailed wiring diagram.

No	Load	Wiring ways	Diagram
1	a singlephase load	The power input line is for phase L1 input terminals, loads are for phase L1 output terminals, PT 1000 is for the T1 terminal, which is linked with the load in the phase L1	Figure 3-1
2	Two singlephase loads	Three-phase power line input, and two single-phase loads are connected separately to phase L1/L2 output terminals. Phase L1 is linked with the PT1000 of the T1 terminal, Phase L2 is linked with the PT1000 of the T2 terminal	Figure 3-2
3	Three singlephase loads	Three-phase power line input, and three single-phase loads are connected separately to phase L1/L2/L3 output terminals. Phase L1/L2/L3 is linked with the PT1000 of the T1/T2/T3 terminal	Figure 3-3
4	A threephase load	Three-phase power line input, and a three-phase loads are connected to phase L1/L2/L3 output terminals. Three-phase load is linked with the PT1000 of the T2 terminal	Figure 3-4
5	A singlephase load and a threephase load	Three-phase power line input, L1 output connected relay input, a single-phase load is connected to the Relay OUT2. Single-phase load is linked with the PT1000 of the T1 terminal. Three-phase load is connected to the Relay OUT1, and L2/L3 phase power output, Three-phase load is linked with the PT1000 of the T2 terminal	Figure 3-5

Table 3-1

### 3.1.1 A single-phase load

The following figure is the overall detailed wiring diagram:

Load situation one: A single-phase resistive load, such as the immersion heater for water heater

Single-phase power input, a single-phase L1 adjustable power output mode, with a PT1000 temperature sensor

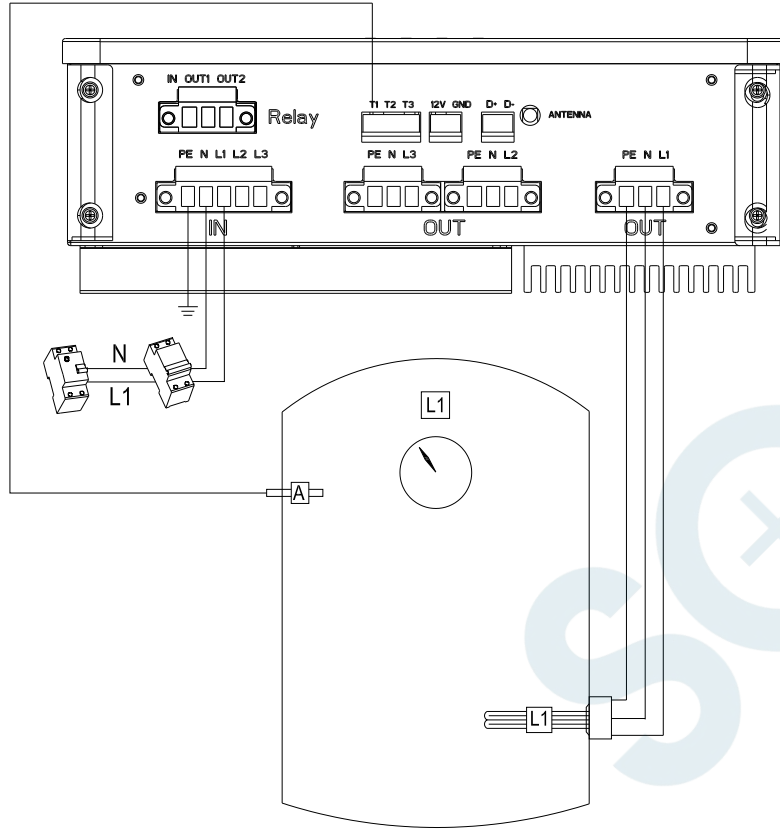

Figure 3-1

### 3.1.2 Two single-phase loads

Load situation two: two single-phase resistive loads, such as two immersion heaters for each water heater

Three-phase power input, a single-phase L1 adjustable power output mode and a singlephase L2 fixed power output mode. Two PT1000 temperature sensors for loads of each phase

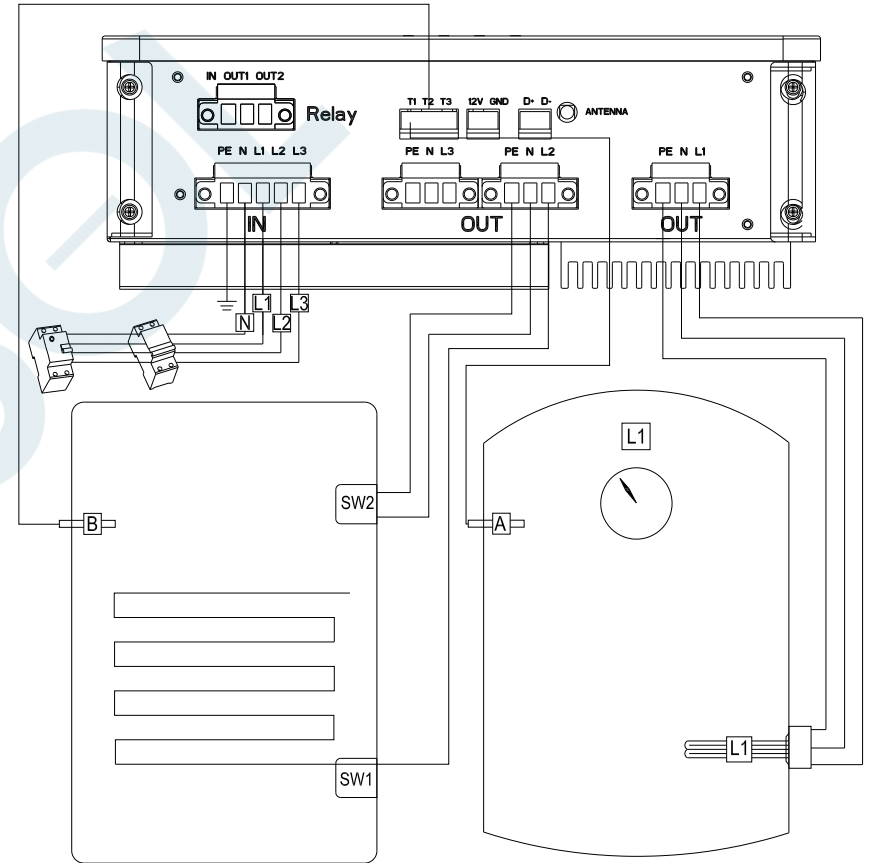

Figure 3-2



### 3.1.3 Three single-phase loads

Load situation three: three single-phase resistive loads, such as one immersion heater for water heater and two heating spaces. Three-phase power input, a single-phase L1 adjustable power output mode and two single-phase fixed power output mode(L2/L3). Three PT1000 temperature sensors for loads of each phase

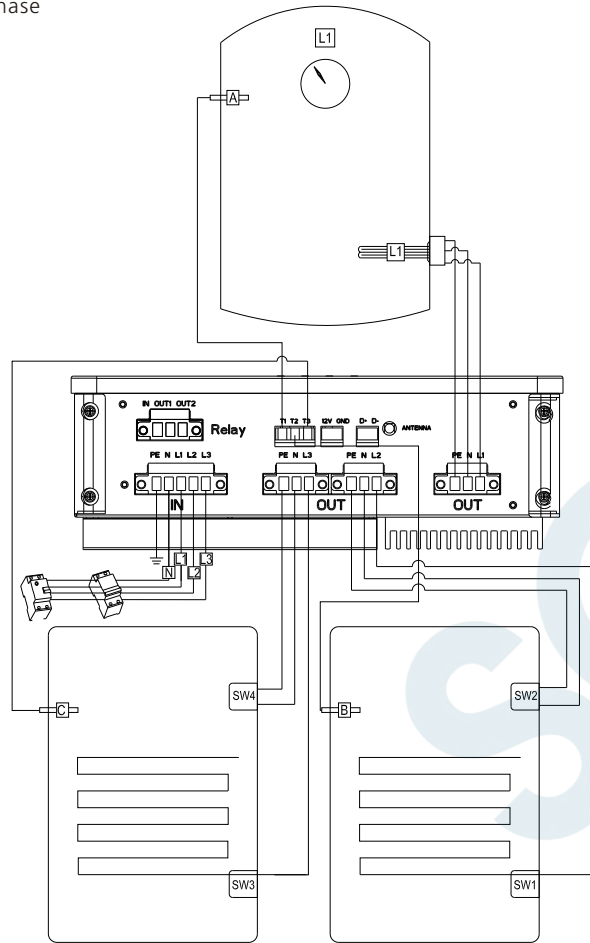

Figure 3-3

### 3.1.4 A three-phase load

Load situation four: a three-phase resistive load, Three-phase power input, among three-phase L1/L2/L3, the power of phase L1 is adjustable while that of L2/L3 is fixed, and one PT1000 temperature sensor for threephase load.

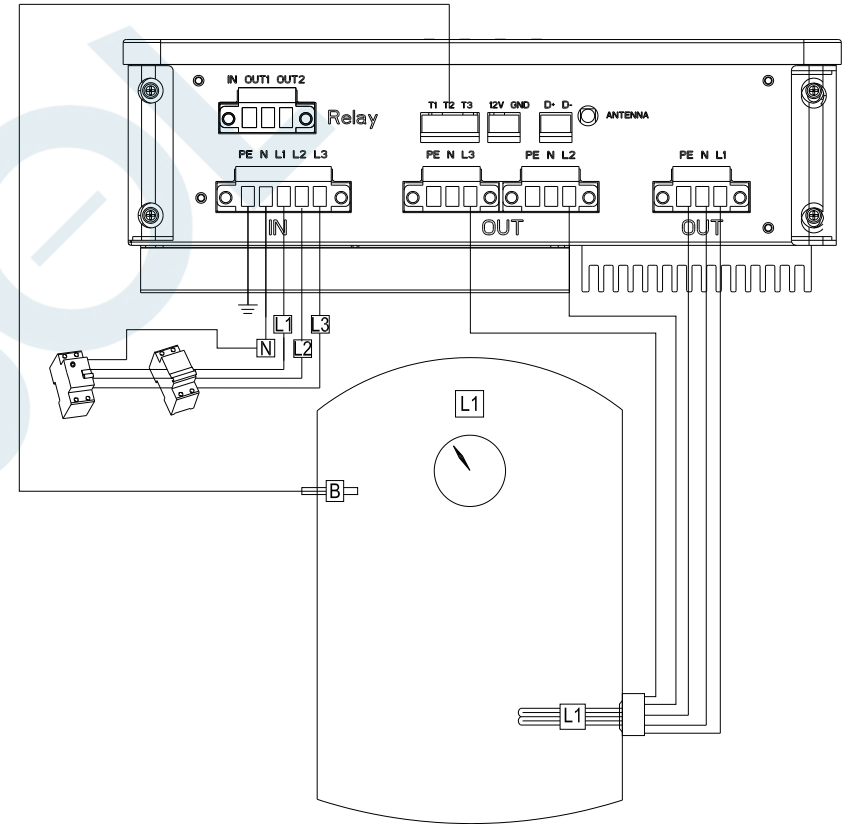

Figure 3-4

### 3.1.5 A single-phase load and a three-phase load

Load situation five: a three-phase resistive load and a single-phase resistive load (automatically switchover between two loads through dry contact relay)  
 Three-phase power input, among three-phase L1/L2/L3, the power of phase L1 is adjustable while that of L2/L3 is fixed. The power of the single-phase load in phase L1 is adjustable. Two PT1000 temperature sensor for each load.

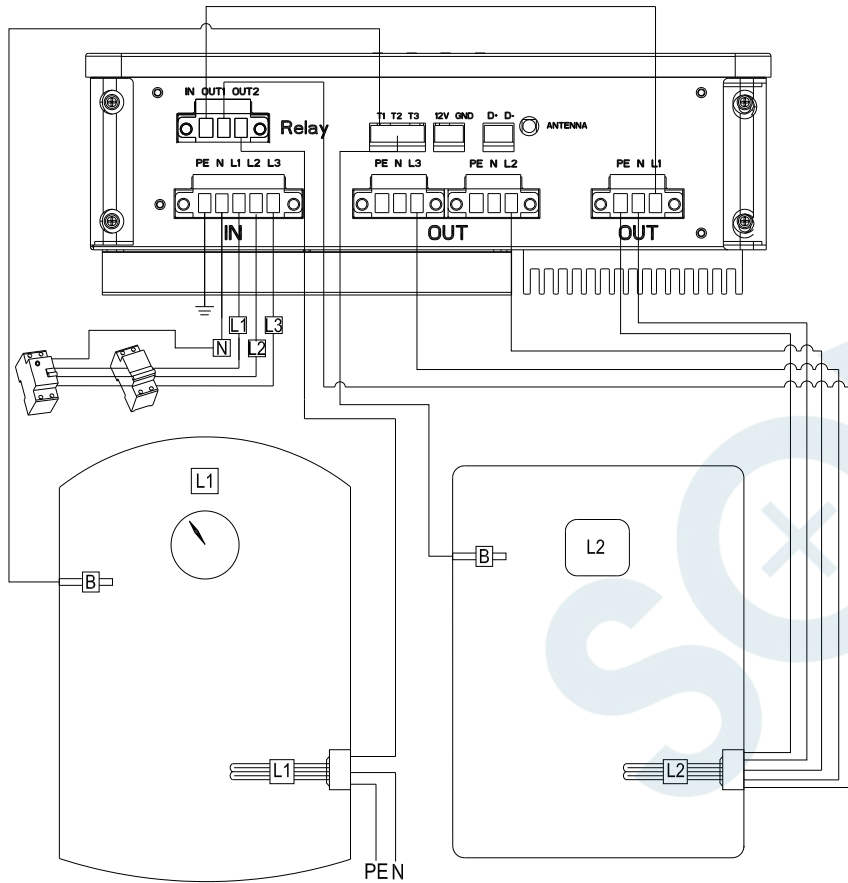

Figure 3-5

Note:

1. Phase L1 has an adjustable power output mode while phase L2/L3 is a fixed power output mode. The adjustable power output mode is used for the PV linkage application, the power output will be adjusted for the resistive load according to the surplus solar power.
2. Three temperature sensors are related to the phase L1/L2/L3 separately. The T1 terminal is related to phase L1, the T2 terminal is related to phase L2 and the three-phase load, T3 terminal is related to phase L3.

### 3.2 Installation Check

After the wiring is completed, corresponding inspections are required to ensure that the equipment will not be damaged due to incorrect wiring, or cause leakage and endanger personal safety. The following table 3-2 is what needs to be checked:

No	Inspection	No	Inspection
1	Check L, N positive and negative connection and in and out direction	4	whether each part of the GroBoost works well normally after power on
2	Whether the grounding wire is connected	5	Whether the GroBoost is fixed well
3	Whether the RS485 D+ and D- wires are connected reversely		

Table 3-2

### 3.3 Work Mode

GroBoost has two main working modes:

smart mode and PV linkage mode. In addition, the mandatory mode can be triggered by pressing the key.

Smart mode:

The GroBoost will accord to the timing period and the temperature being set to work, which has 5 groups of settable time periods. During the smart mode, the device will work based on its rated power, however, the power output of the phase L1 is a settable

PV linkage mode:

The GroBoost can get a real-time power flow through the ShineLink system. By setting the execution strategy, the GroBoost will automatically work and adjust its output power when there is a certain power exporting to or importing from the grid, to make full use of the solar energy and maximize the solar self-consumption. In addition, there is also a thermal protection function to guarantee the water temperature during the time period and temperature point being set when the offline happens or solar energy is insufficient.

Mandatory mode:

Triggered by manual button, and it could enable the GroBoost to work forcedly, and stop until it reaches the maximum temperature (default temperature is 65 °C), often being used in an emergency situation. For security, the maximum duration of mandatory mode is 2 hours by default.

### 3.4 Display and Setting

GroBoost has four LED lights and four function buttons, which work with multiple devices at the same time. The operation condition and mode of the devices can be monitored and set by the ShineSever or ShinePhone platform, and can also be achieved through the basic indicator lights and buttons. Each LED light and button correspond to a load, and the status of LED light will indicate different working status, as shown in Table 3-3:

Indicator light	Features
Led1	Led1 light is on means the load of phase L1 is working Led1 light is off means the load of phase L1 is stand by
Led2	Led2 light is on means the load of phase L2 is working Led2 light is off means the load of phase L2 is stand by
Led3	Led3 light is on means the load of phase L3 is working Led3 light is off means the load of phase L3 is stand by
Led4	Led4 light is on means the power source is connected while it is off mean it's out of power
Take turn to light from LED1 to LED3	The machine is during PV linkage mode (When there are multiple devices, one of them is in the photovoltaic state.)
Take turn to light from LED3 to LED1	The machine is during Smart mode
Led3	Flash once every 5S RF device is not connected

Table 3-3

When GroBoost is working normally, the real-time operating status will be displayed through LEDs. The specific content is shown in Table 3-4:

Button	Button state	Indicator light	Flashing status	Features
L1	dog	Led1	Led1 flashes	L1 device switch forced mode / cancel forced mode
	Long press 3S		Led1 flashes three times	L1 equipment switches photovoltaic mode/
	Long press 3S		Led1 flashes	L1 device switch smart mode/
L2	dog	Led2	Led2 light flashes	L2 channel equipment switch forced mode / cancel forced mode
	Long press 3S		Led1 flashes three times	L2 way equipment switches photovoltaic mode/
	Long press 3S		Led1 flashes	L2 way equipment switch smart mode/
L3	dog	Led3	Led3 light flashes	L3 way equipment switch forced mode / cancel forced mode
	Long press 3S		Led3 flashes three times	L3 equipment switch photovoltaic mode/
	Long press 3S		Led3 light flashes	L3 way equipment switch smart mode/
Home	Long press 3S	Led3	Quickly flash into the pairing button state Release: 0.5S frequency flash for up to 2 minutes	RF device pairing
	Long press 15S		Quickly flash into the reset button state	Release the button to reset
	Long press 30S		Quickly flash into the state of the factory reset button	Release the button to restore factory settings

Table 3-4

Pairing process:

STEP1

Press the Home button of GroBoost for 15S, the LED3 light flashes at a frequency of 0.5S

STEP2

Short press the pairing button of host (ShineLanBox), as shown on the left in Figure 5.1, the pairing light ④ of the host flashes quickly, they are pairing;

STEP3

The GroBoost LED3 light does not flash, the host (ShineLanBox) pairing light ④ is off, the device light ③ flashes, and the pairing is successful;

Note:

The flash number of times of the ShineLanBox device light ③ means the number of devices connected to ShineLanBox.

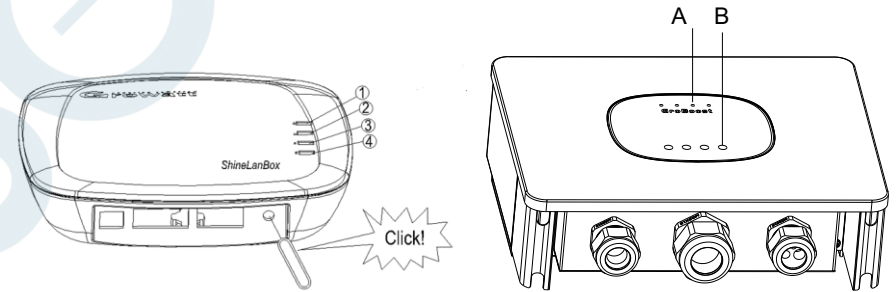

Figure 3-6

## 4 Device parameters

The equipment specifications are shown in Table 4-1

category	Item	Parameter	
General parameters	Dimension (W/H/D)	288mm *227mm *101mm	
	Weigh	3.5kg	
	User manual	Chinese and English	
	Power Supply	230Vac/3*230Vac 50Hz	
	Operating Voltage Range	180Vac-260Vac	
	Power consumption	5W	
	Maximum load power	3.6kW/10.8kW (Single channel adjustable)	
	Operating Temperature		-25°C~+60°C
			Full-load:<45°C
	Storage Temperature	-40°C~+70°C	
	Protection level	Ip54	
	Relative humidity (no condensation)	5-95% RH	
	Installation	Wall-mounted	
	Certificate	CE/Rohs	
	RS485	Support	
Relay output	Support		
Temperature Sensor	Max. 3*PT1000		
Display	LED	4*LED lights	
Device Management	Number of managed devices	Up to 3	
	communication method	RF communication/RS485	
	Maximum communication distance of RF	100M	

Table 4-1

## 5 Common Problem

Quick ways to deal with common problems.

### 5.1 Load LED1/LED2/LED3 status light is abnormal

(1) Confirm the current load working mode and whether the key switch status is normal.

### 5.2 LED3 status light flashes per 5S

(1) Check whether the GroBoost antenna is well connected;  
(2) Check whether the GroBoost has been paired with ShineLanbox, try to pair again;  
(3) Check the distance between GroBoost and ShineLanbox, is it too far or is blocked by a wall, try to move ShineLanbox closer to GroBoost.

### 5.3 RS485 can't communicate

(1) Check whether the 485 connection is wired, try to replace the 485 cable;  
(2) Check whether the communication parameters are correct, the baud rate, etc.

## 6 APP Register

### 6.1 Register

Before using ShinePhone APP first time, the user must register an account in advance.

There are three steps when users register the account:

## STEP1 Fill in the account registration information

14:50  
Register

Current server address:

\* Country Choose country

\* Username Enter username

\* Password Enter password

\* Repeat password Repeat password

Phone number Enter phone number without country co...

\* Email address Enter email

Installer code Input installer code

User agreement

Register

Figure 6-1

Fill in account information. To fill in the account information, please select the account country, user name, password, email address, and installer number.

## STEP2 Add Plant

14:51  
Add Plant Skip

\* Plant name Enter the Plant name

\* Installation date Select the installation date

Plant address

Get from the map Automatic Manual

\* Antarctica City

Please enter the full address

Longitude Latitude

\* Time zone +08

\* PV capacity(W) PV capacity

\* Plant type

Residential plant Commercial Plant Ground-mounted plants

(Conversion standard based on 1kWh power generation)

Fund Revenue DOLLAR

PV Plant picture Upload Picture

Figure 6-2

Add power station name, installation date, country and city, detailed address, time zone, total power of components, power station type, capital gains, power station pictures.

### STEP3 Add datalogger

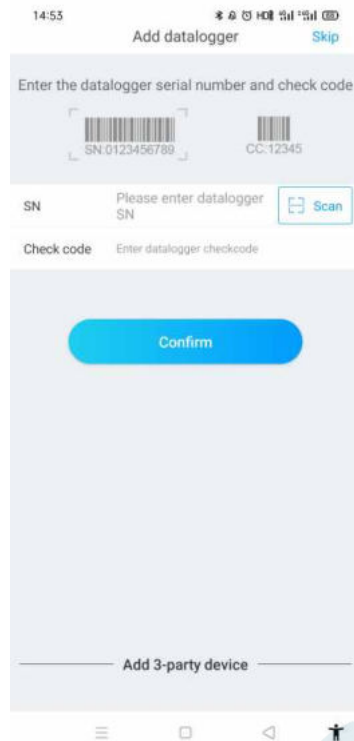

Figure 6-3

You can add a data logger by entering the serial number or scanning the collector's barcode, and entering the collector check code.

## 7 GroBoost Setting the Groboost via Shinephone APP

### STEP1 Add device

After adding Lanbox data logger and matching with the Groboost, the device will be displayed in the Grohome page(device list).

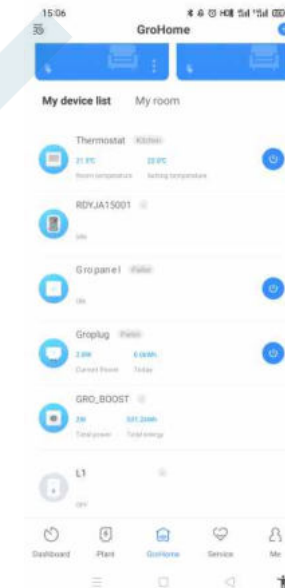
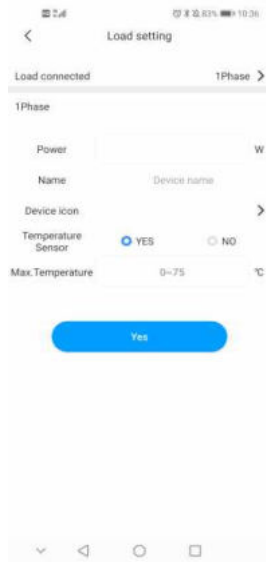
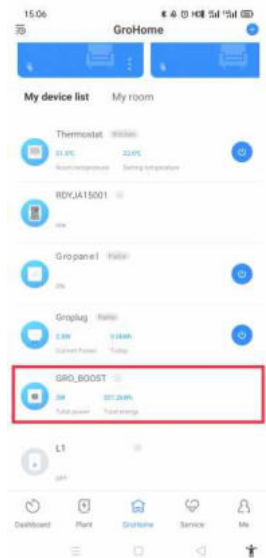

Figure 7-1

Initialization:

Click GroBoost to enter the initialization page, configure the load information Groboost binding (single phase, three phase, single phase + single phase, single phase + single phase + single phase, single phase + three phase), and after setting the load related information, the real-time information of the load can be displayed and the load can be controlled (Groboost can connect up to 3 resistive heating loads).



Load type: confirm the connected load;

You need to configure the basic information of each connected load separately: working power, custom name, settable load icon, and confirm whether the temperature sensor is connected (after connecting the extra temperature sensor, the load can be detected and controlled for temperature );

## STEP2 Mode setting

Mode settings can be divided into two types, one is smart mode, the other is PV linkage mode;

Note: Both temperature setting and temperature detection need to be set and operated with a temperature sensor.

Intelligent mode:

Power adjustment enable: only L1 can be set (can control load working power); There are two heating modes in the smart mode: constant temperature and timing control modes, among which the L1 function is adjustable;

Constant temperature (temperature sensor needs to be installed): set the constant temperature, the device will always keep at the certain temperature;

Timing: To set the timing, you need to fill in the time, set the temperature and times of repetition(up to 5 times). You can set different temperature values according to different time periods, temperature requirements and usage.

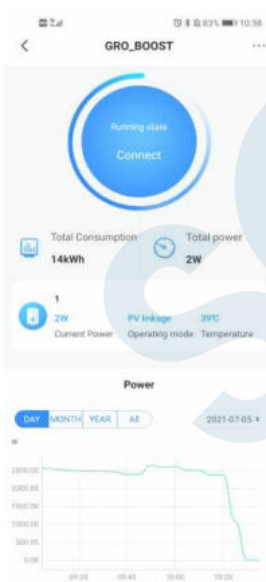
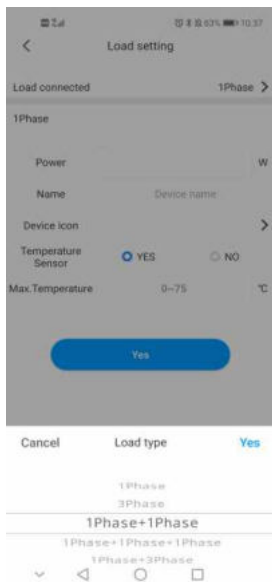

Figure 7-2



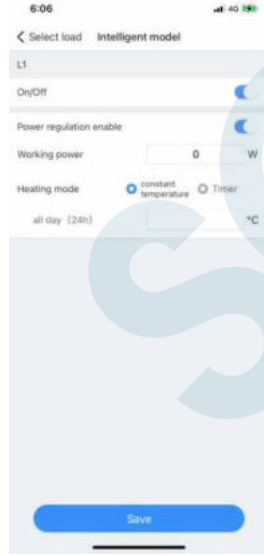
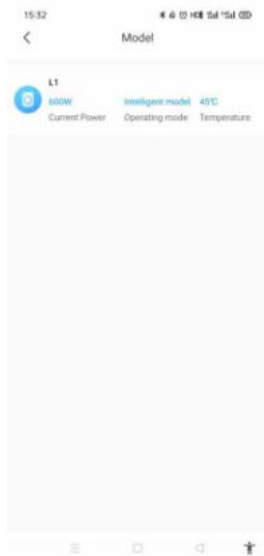
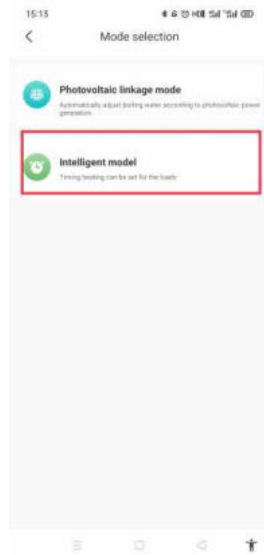
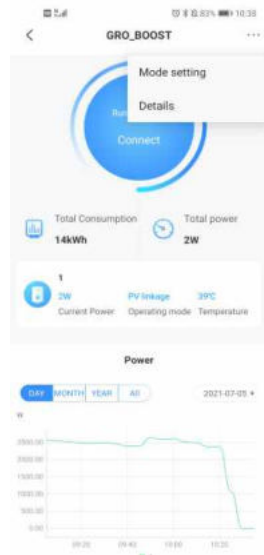

Figure 7-3

**Photovoltaic linkage mode:**

Select the load to be controlled, select the priority, enter the linkage name, confirm whether the linkage meter is correct, turn on the linkage enable switch, control linkage execution time, and set linkage tasks.

Linkage details need to save at least one load, click on the load to enter the advanced settings:

Recommended settings:

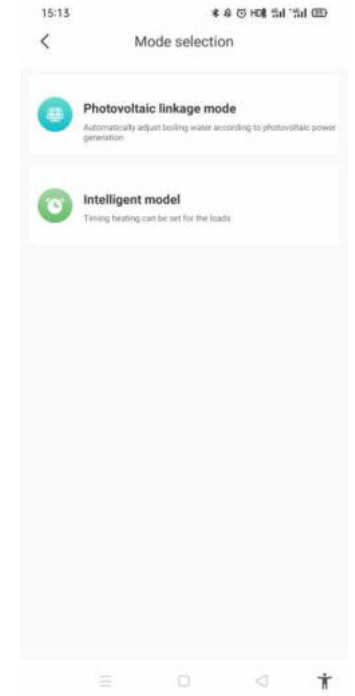

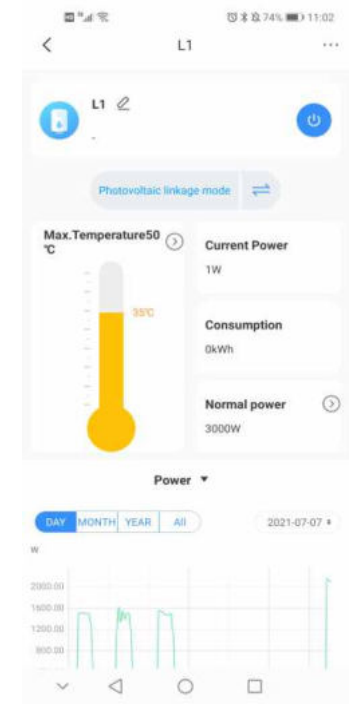
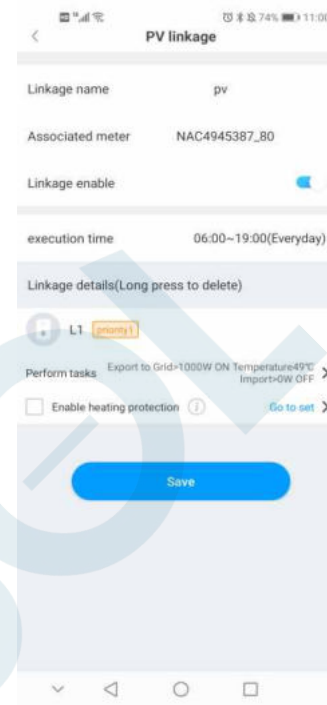
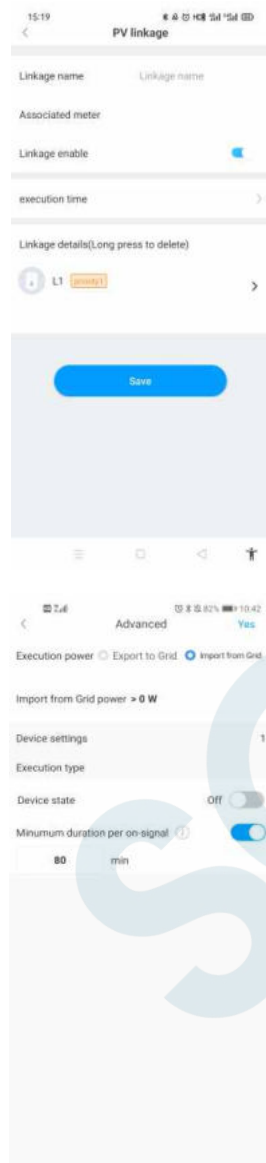
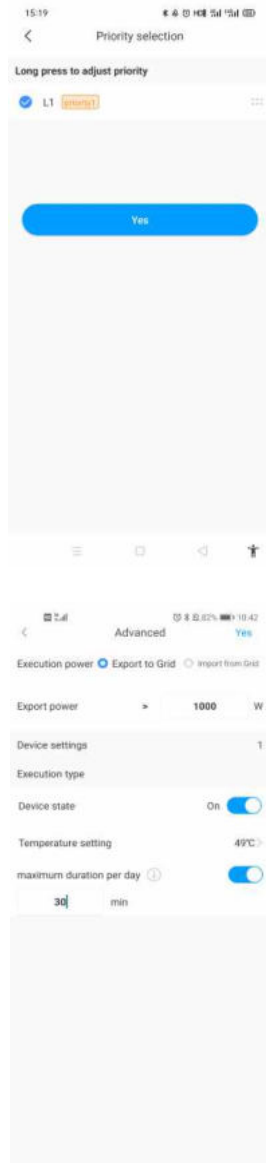

Figure 7-4

When photovoltaic power is fed into the grid, turn on heating and set the working parameters of the device; such as: set the temperature and the maximum operating time of the device to avoid excessive operation and waste of electricity;

When the power drawn from the grid reaches a certain value, it is recommended to turn off the equipment and set the minimum operating time of the equipment (to ensure that the equipment works normally and meet daily needs);

Set the execution time. The user can set the effective time of the linkage to make the task run within the set time. After the time period is set, the cycle can be set. The cycle is divided into three situations: once, repeat, and custom days of the week. When the user does not set the timing, and starts the linkage.

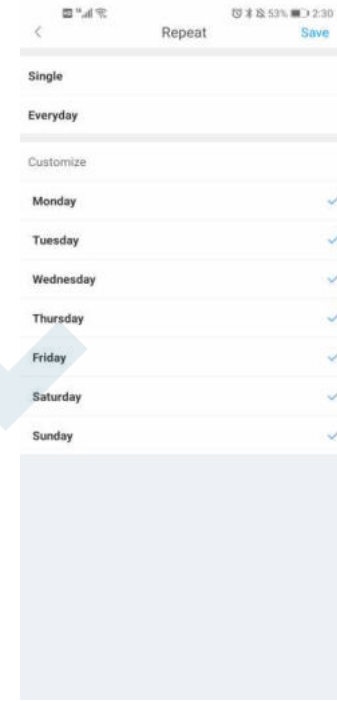
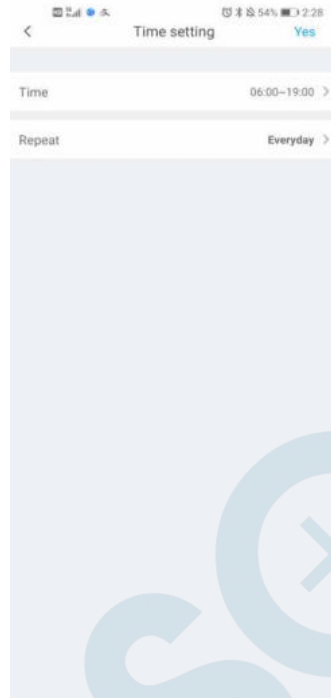
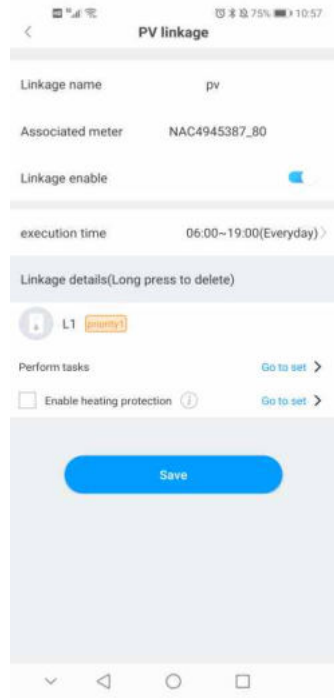

Figure 7-6

Regarding the heating guarantee function: it belongs to the backup plan setting function. The purpose of the heating guarantee function is to ensure that certain time periods are heated to a fixed temperature value. It can also use the grid to continue heating when the photovoltaic is not generating electricity and there is no sunlight so as not to affect the daily life use.(Up to 5 heating times can be added).

Figure 7-5

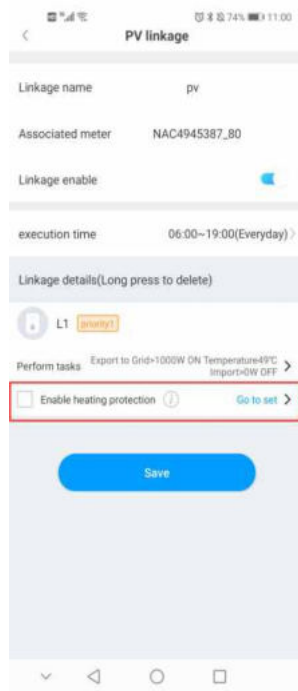

Figure 7-7

### STEP3 Reset load information

On the GroBoost homepage, click the upper right corner to enter the detailed information, select the connected load, and the system will prompt whether to reset it. After confirming, the original load information will be overwritten.

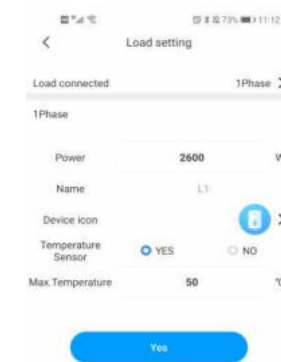
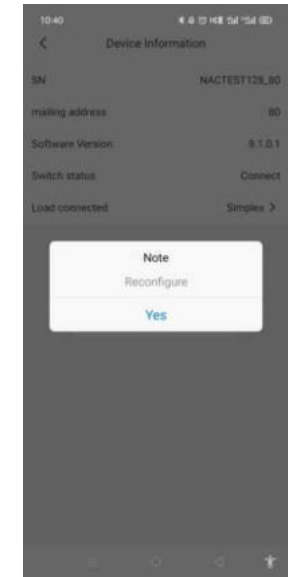

Figure 7-8

Load settings include the connected load (other loads can be replaced), power, name, device icon and temperature sensor. There is no need to set the maximum temperature when the temperature sensor is not connected.

### STEP4 Load management

The load management interface has the functions of editing, turning on and off the load, switching the working mode, setting the maximum temperature, current power, power, setting the rated power, graphs (power, current, voltage, temperature), and deleting the load.



Figure 7-9

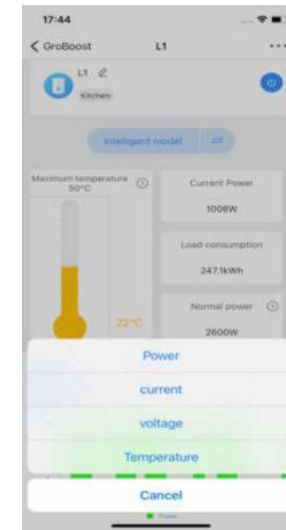
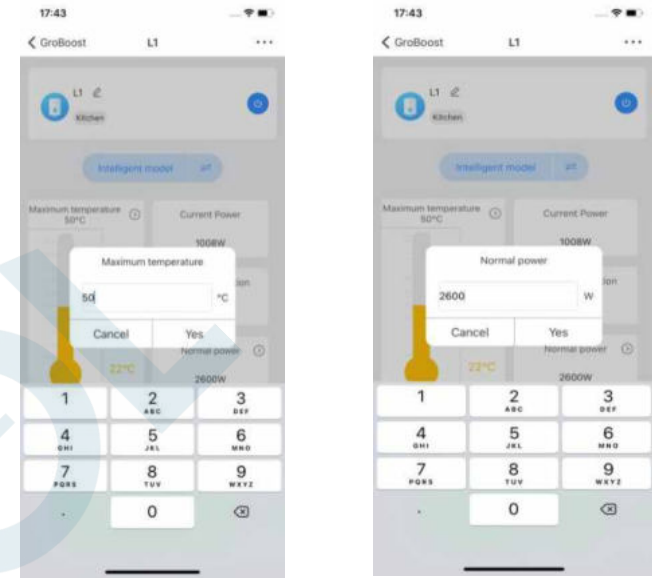

Figure 7-10

## 8 Contact us

Growatt New Energy provides customers with a full range of technical support. Users can contact the nearest Growatt new energy office or customer service point, or they can contact the company's customer service center directly.

Name: SHENZHEN GROWATT NEW ENERGY TECHNOLOGY CO.,LTD

Address: No.28 Guangming Road, Shiyan Street, Bao'an District, Shenzhen, P.R.China

Customer Service Hotline: +86 755 27471942

E-mail:service@ginverter.com

Company website: www.ginverter.com

The logo for SOLSOL is displayed in a bold, blue, sans-serif font. The first 'O' contains a white plus sign (+), and the second 'O' contains a white minus sign (-). A large, light blue watermark of the word 'SOLSOL' is oriented diagonally across the right side of the page, overlapping the main logo.

SOLSOL s.r.o.

Králova 298/4,Brno 616 00

Česká republika

E-mail: sales@solsol.cz

www.solsol.cz